



BREAKERS & ATTACHMENTS

BREAKER MODEL

95 ST

STRONGER

Piston Design

Stronger strike with its increased impact power and enhanced piston design!

Membrane and Accumulator

With its highly resilient accumulator and membrane, our breakers impact with the same energy on every single stroke, thus providing maximum efficiency even when working on the hardest materials.

MORE DURABLE

Dual Retainer

Dual retainer design makes sure that the tool impacts with more balance.

Wearing Plates

Our breakers have longer lifetimes thanks to their highly resilient wearing plates which were specially designed for operating conditions.

MORE RELIABLE

Minimum Vibration

Minimum vibration and maximum performance with our excellent impact absorbant vibration buffers and polyurethane-covered tie-rods.

Hydraulic Cushioning

If the breaker blank-fires during operation, thanks to our hydraulic cushioning feature the piston won't hit the cylinder, therefore prolonging the lifetimes of the components.



TECHNICAL INFORMATION

95 ST

Operating weight (a) kg	950
Oil Flow l/min	70~120
Impact Rate (b) bpm	360~630
Operating Pressure (c) bar	125~130
Input power (d) kW	14.6~26
Relief Pressure bar	190
Back Pressure Max. bar	8
Tool Diameter mm	100
Noise Level (e) LWA (dB)	128
Carrier Weight (f) t	10~16

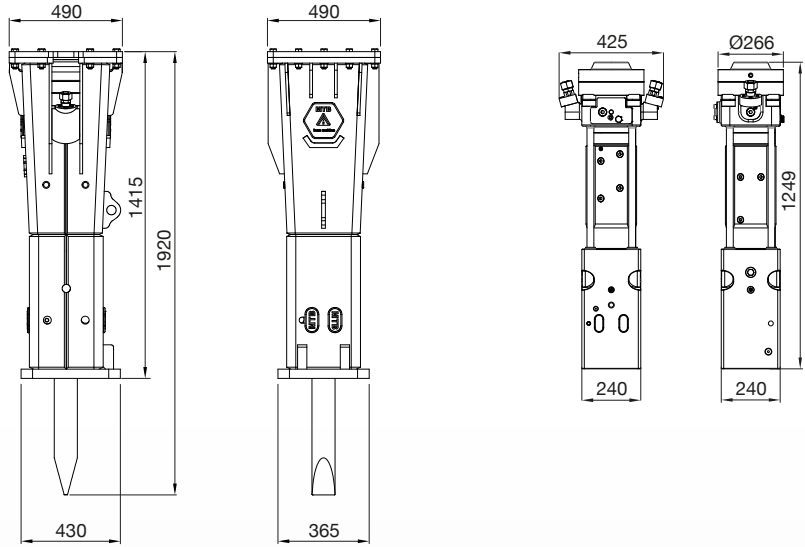

(a) It includes the approximate weight of the breaker, bracket, standard tool and hose weights.

(b) Actual impact frequency depends on the oil flow, oil viscosity, temperature and the material to be broken.

(c) Actual pressure depends on the oil flow, oil viscosity, temperature, material to be broken and the return pressure.

(d) Input power directly effects fuel consumption. Low input power (kW) requirement means low fuel consumption.

(e) Guaranteed sound power testing results according to directive 2000/14/EC (Guaranteed dB(A)=Measured Value +3 dB).

(f) If the carrier machine is out of the optimum range, ask the carrier machine manufacturer for allowed attachment weight.

TOOL PROPERTIES

	Pyramid	Moil	Chisel	Blunt
Operating Principle				
Key Properties	<ul style="list-style-type: none"> ○ Breaking in four directions ○ General demolition 	<ul style="list-style-type: none"> ○ Breaking in all directions ○ Suitable for general use 	<ul style="list-style-type: none"> ○ Breaking in two directions ○ Suitable for general purpose by demolition 	<ul style="list-style-type: none"> ○ Good energy transfer ○ Demolition – Impact breaking

SPECIAL TOOLS

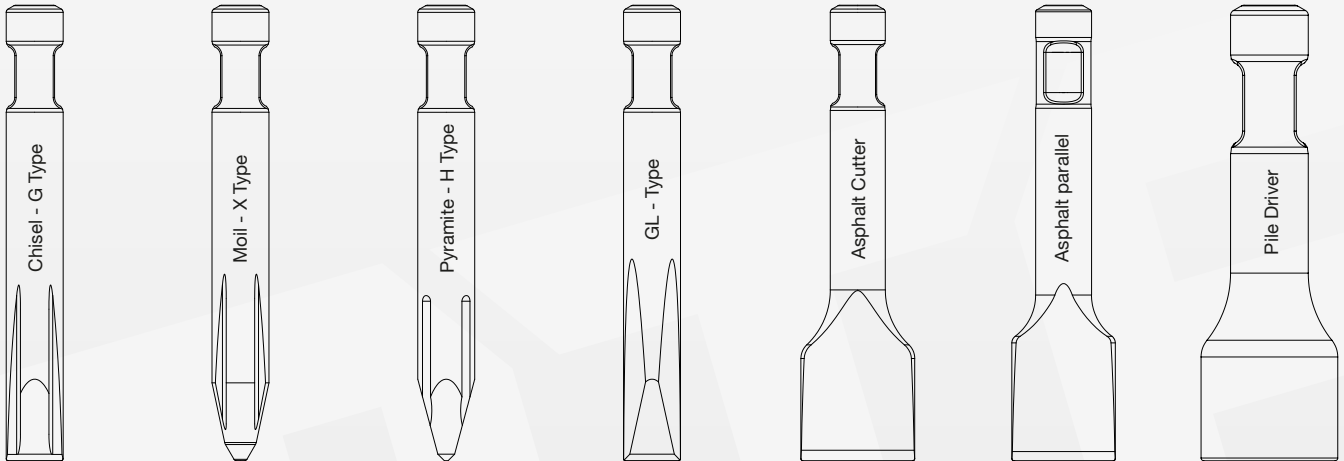

Rev. 150822



Factory

Bahçelievler OSB Mh. 11. Cd. No: 4A
59510 Kapaklı / Tekirdağ - TURKEY
+90 282 768 25 00

www.mtbbreakers.com - info@inanmakina.com



WARNING! The visuals and the information in this brochure are standard or optional depending on the version of the product.

İNAN MAKİNA A.Ş. saves the right to modify the values and designs shown in this brochure without notice.